

1

Draw the reflection of **all** the shaded shapes in the mirror line.

[2013]

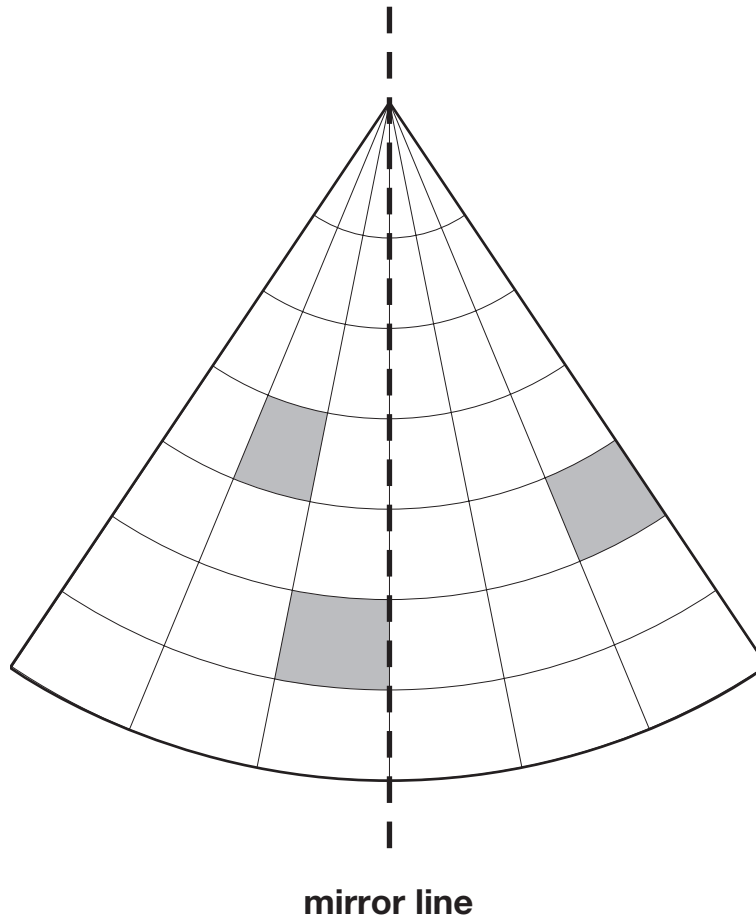

[1 mark]

2

Draw in and shade 3 triangles to complete the reflection in the mirror line.

[Extra]

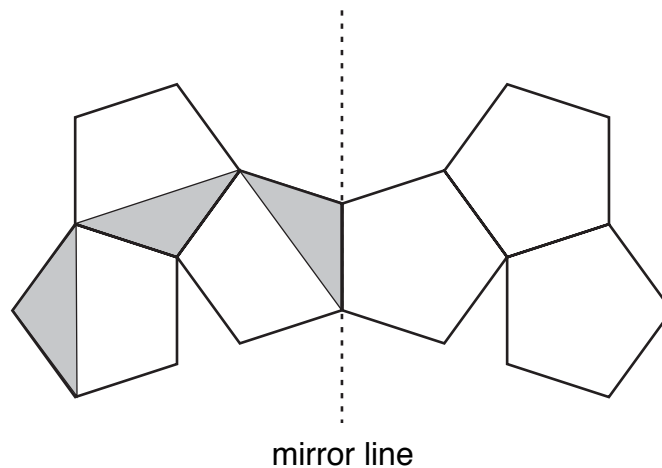

[1 mark]

3

[2008]

Draw **two** more circles on this grid to make a design that has a line of symmetry.

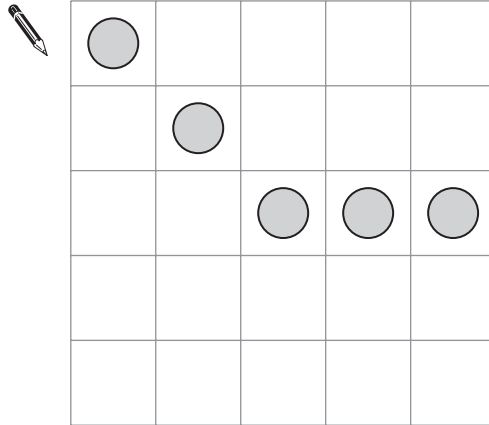

[1 mark]

4

[2004]

Complete the diagram below to make a shape that is symmetrical about the mirror line.

Use a ruler.

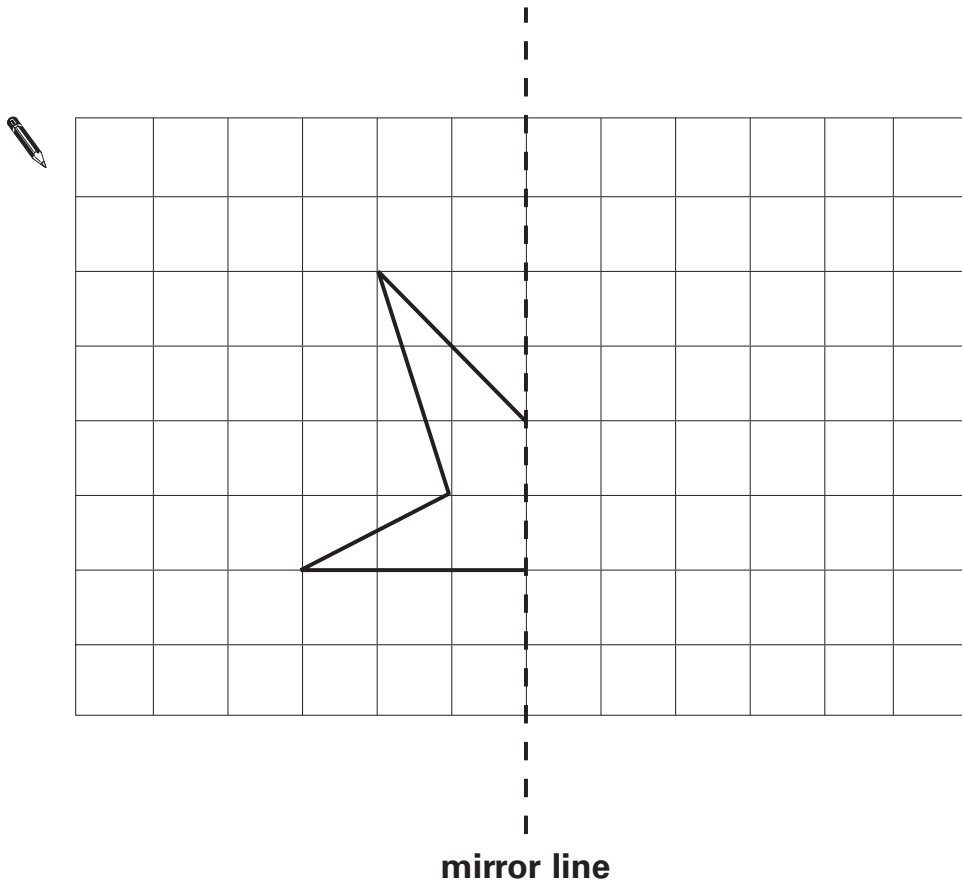

[1 mark]

5

These two shapes are made from equilateral triangles.

[2006]

Draw **one** line of symmetry on each shape.

Use a ruler.

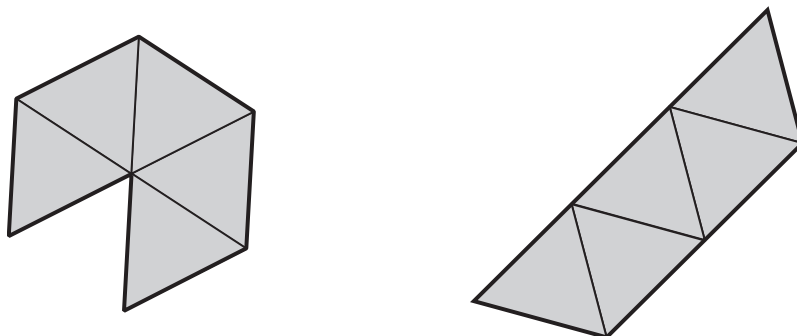

[1 mark]

6

Complete the diagram below to make a shape that is symmetrical about the mirror line.

[2003]

Use a ruler.

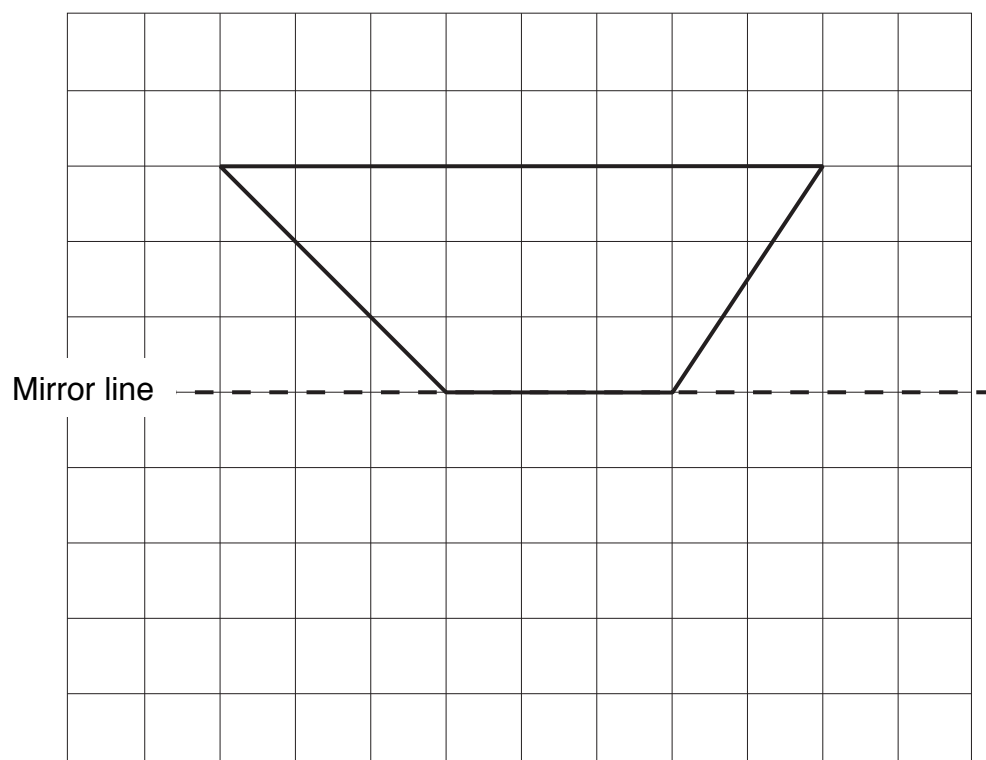

[1 mark]

7

These diagrams are made from regular octagons.

[2011]

Draw the line of symmetry on each diagram.

Use a ruler.

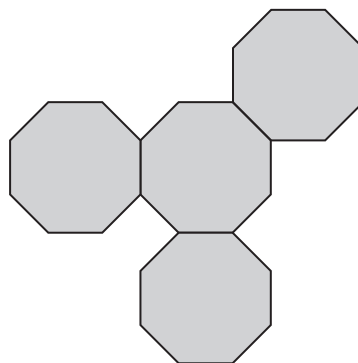
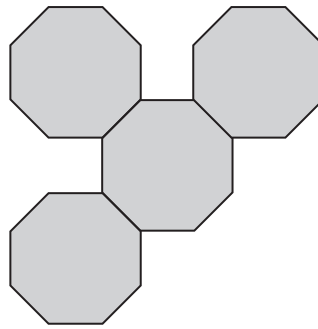
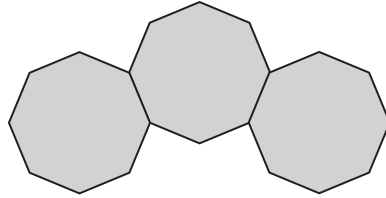

[2 marks]

8

Complete this shape so that it is symmetrical about the mirror line.

[2014]

Use a ruler.

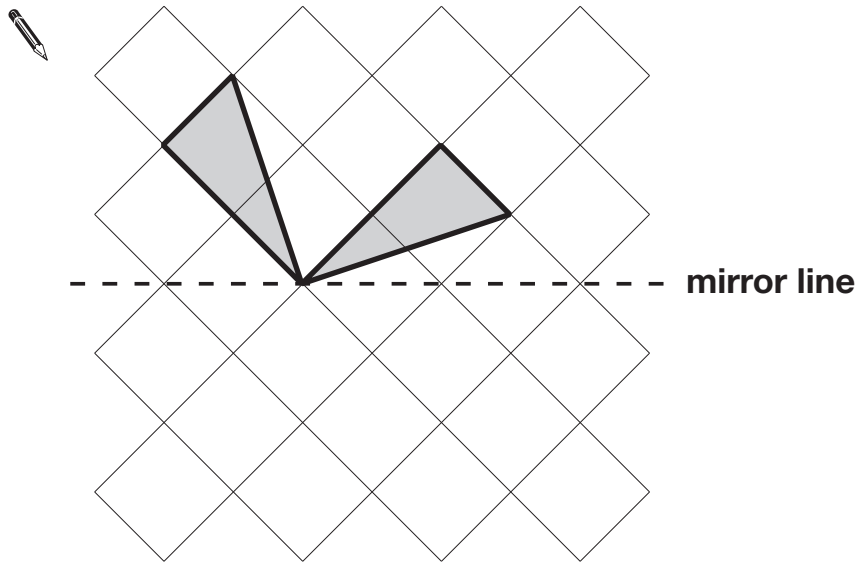

[1 mark]

9

Shade in **two more squares** to make this design symmetrical about the mirror line.

[2001]

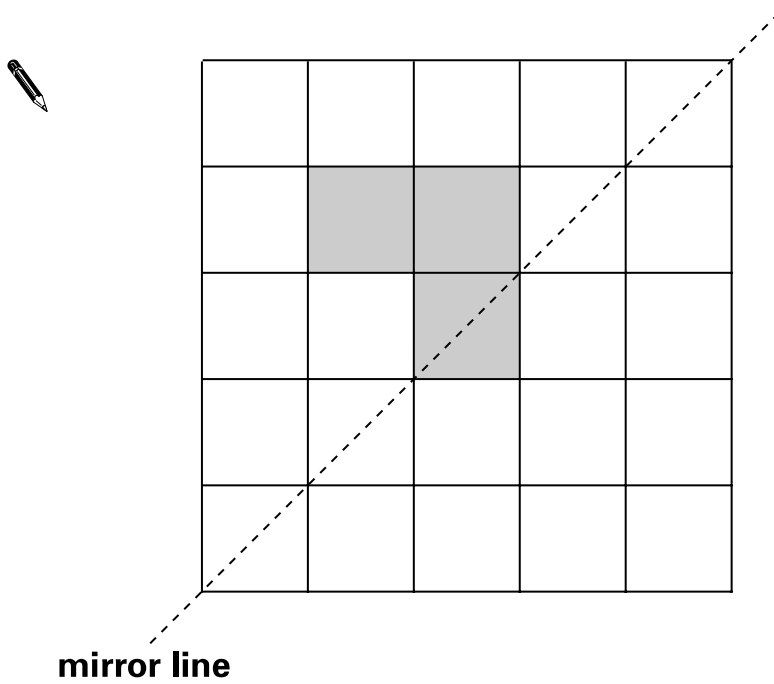

[1 mark]

10

These three square tiles have symmetrical patterns on them.

[2015]

Draw the line of symmetry on each tile.

Use a ruler.

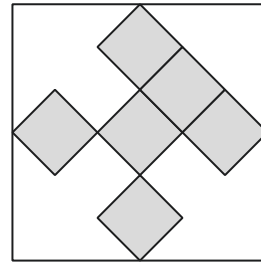
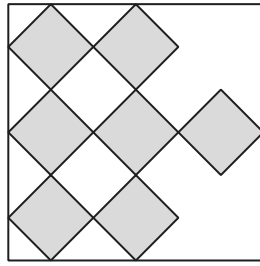
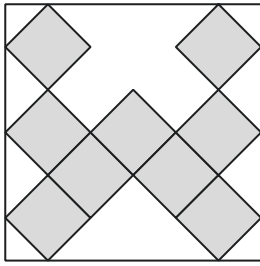

[2 marks]

11

This diagram shows a shaded shape inside a border of squares.

[2016]

Draw the reflection of the shape in the mirror line.

Use a ruler.

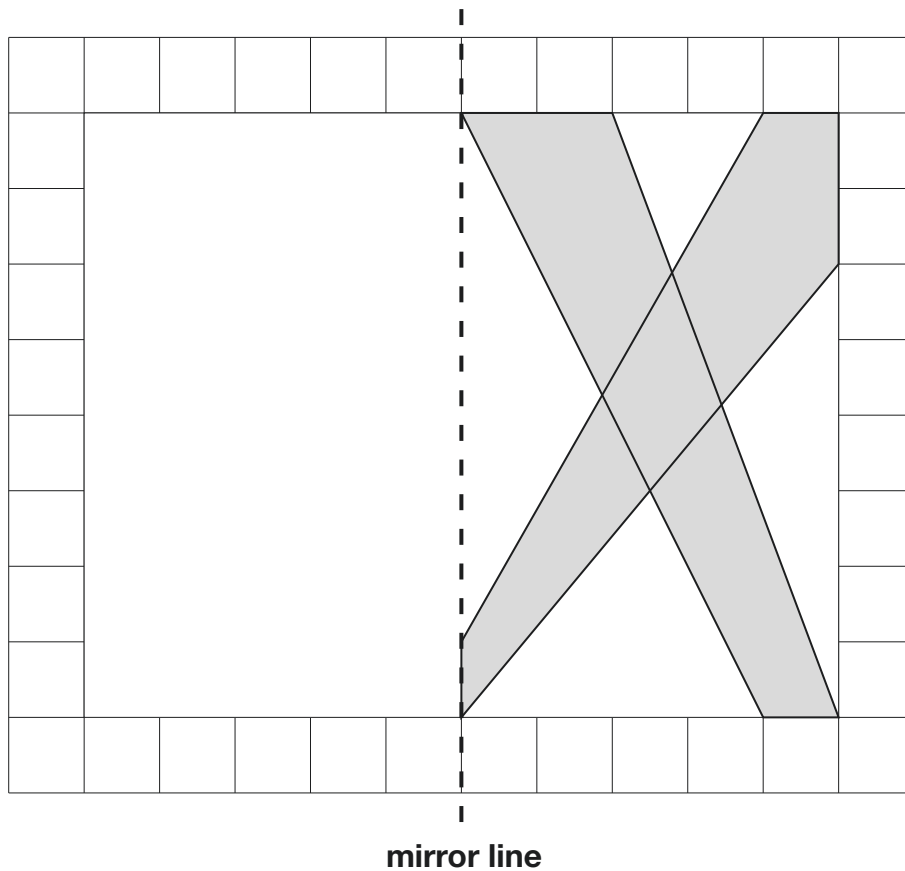

[1 mark]

12

Here is a shaded square on a grid.

[Extra]

Shade in 3 more squares so that the design is symmetrical in both mirror lines.

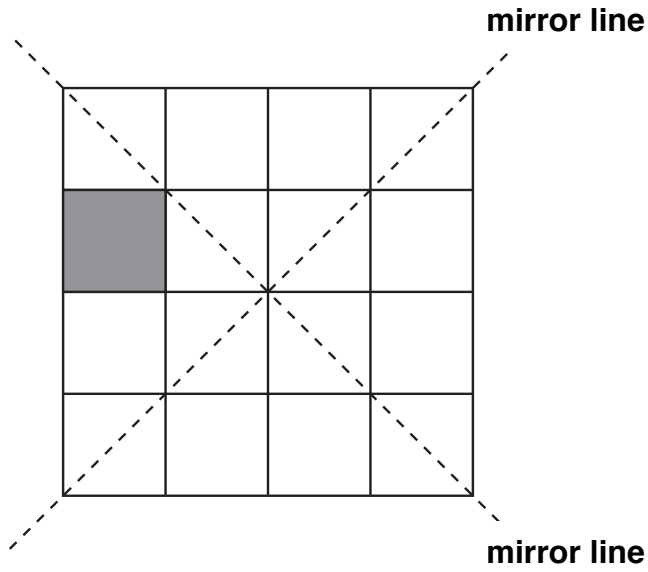

[1 mark]

13

Here are five shapes on a square grid.

[2004]

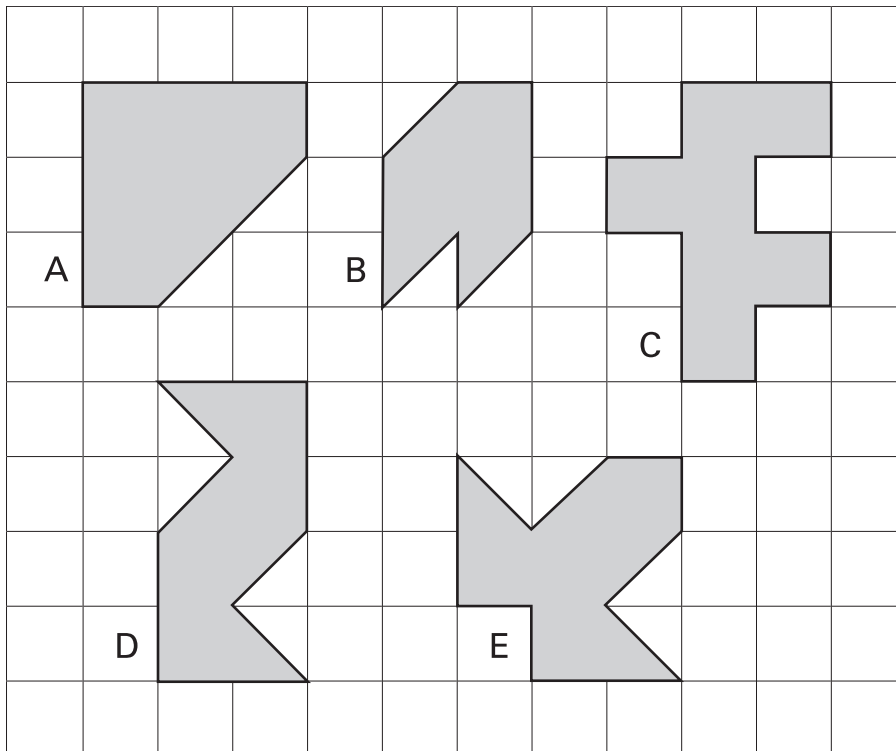

Write the letters of two shapes which have a line of symmetry.



..... and

[1 mark]

14

Here is a grid with eight squares shaded in.

[2003]

Shade in **two more** squares to make a symmetrical pattern.

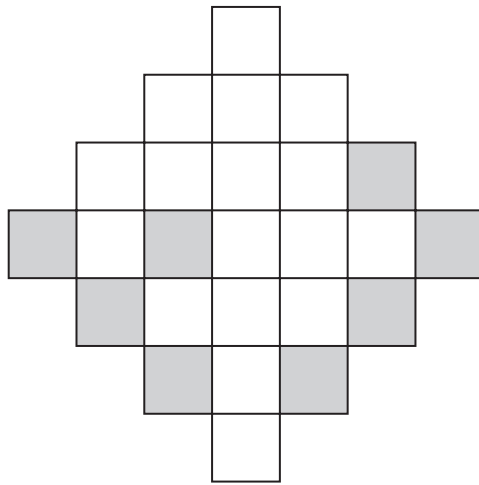

[1 mark]

15

Here are five quadrilaterals on a square grid.

[2009]

A dotted line has been drawn on each quadrilateral.

For each shape, put a tick (✓) if the dotted line is a line of symmetry. Put a cross (✗) if it is not a line of symmetry.

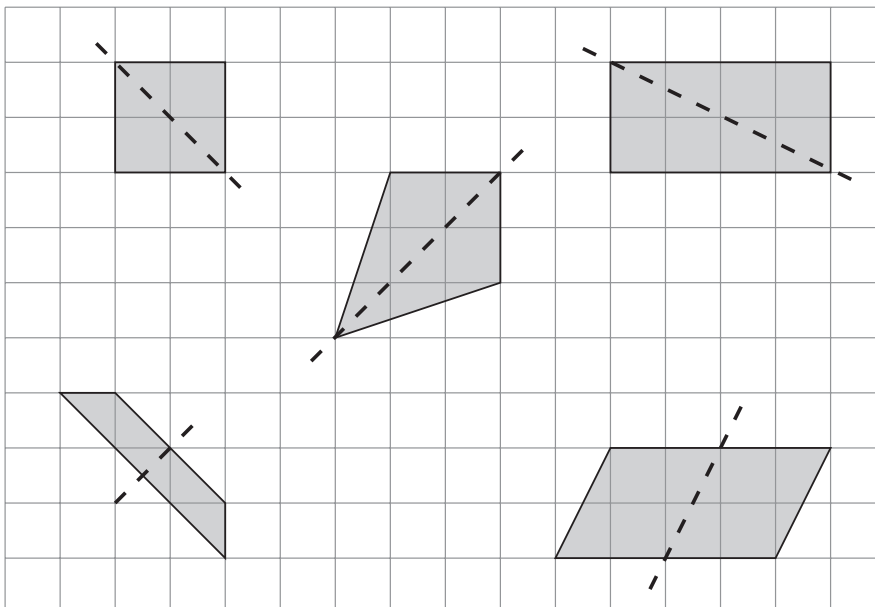

[1 mark]

16

Here is a design on a square grid.

[2012]

Complete the design so that it is symmetrical about the mirror line.

Use a ruler.

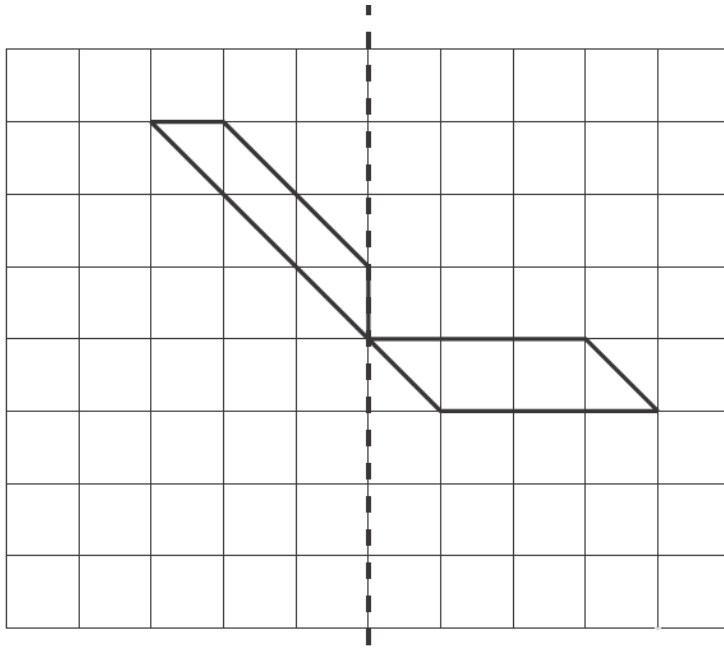

mirror line

[1 mark]

17

Here is part of a shape on a square grid.

[2005]

Draw **two more** lines to make a shape which has a line of symmetry.

Use a ruler.

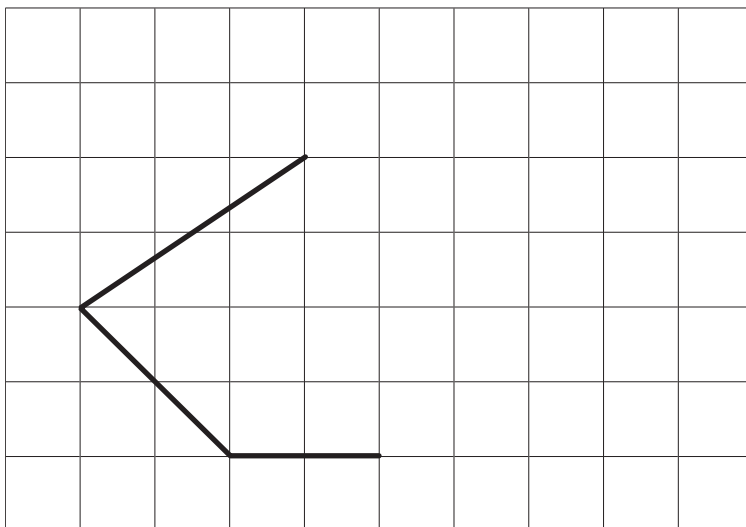

[1 mark]

18

Amy has some circular tiles and some rectangular tiles.

[2010]

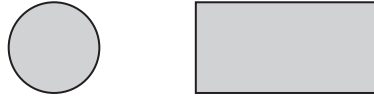

She makes these patterns with them.

For each pattern, put a tick (✓) if it has a line of symmetry.
Put a cross (✗) if it does not.

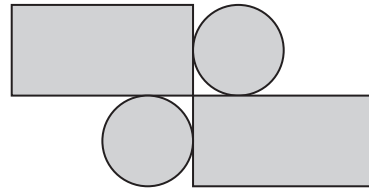
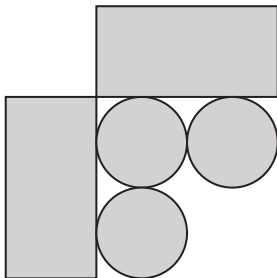
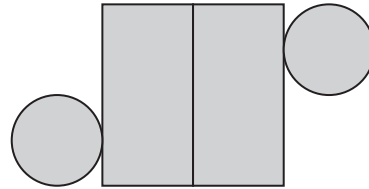
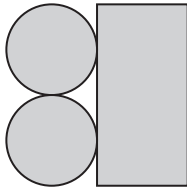

[1 mark]

19

Here are four designs made from two sizes of circles.

[2013]

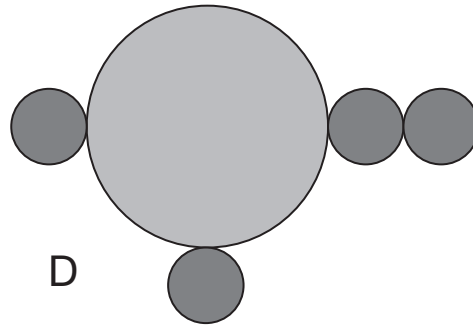
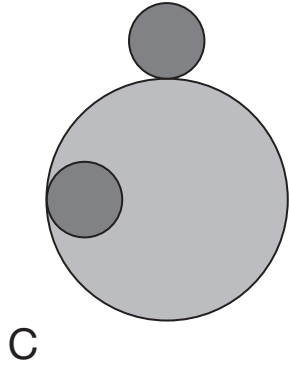
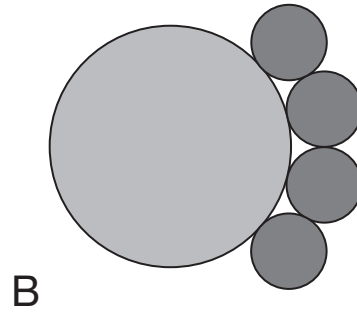
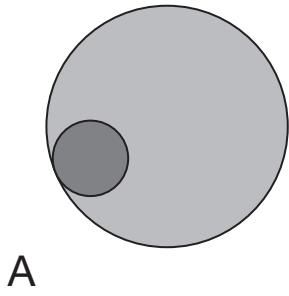

Write the letters of all the designs that have line symmetry.



[1 mark]

20

Shade 5 squares, on the grid below, to draw a pattern that has more than one line of symmetry.

[Extra]

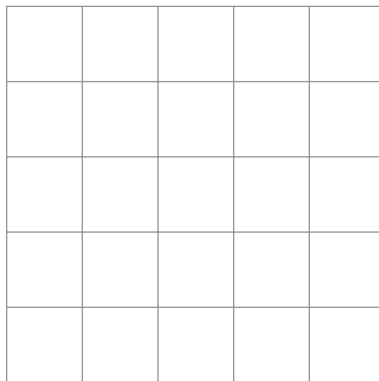

[1 mark]

21

[2011]

Shade **two** squares and **one** triangle to make this design symmetrical about the mirror line.

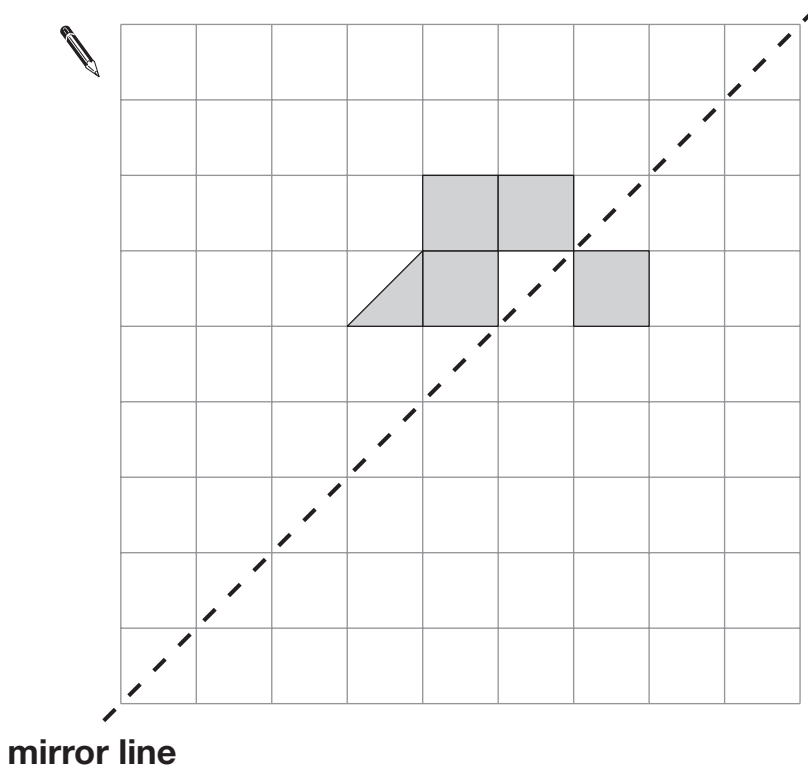

[1 mark]

22

[2007]

Here are five patterns.

For each pattern put a tick (✓) if it has a line of symmetry.
Put a cross (✗) if it does not.

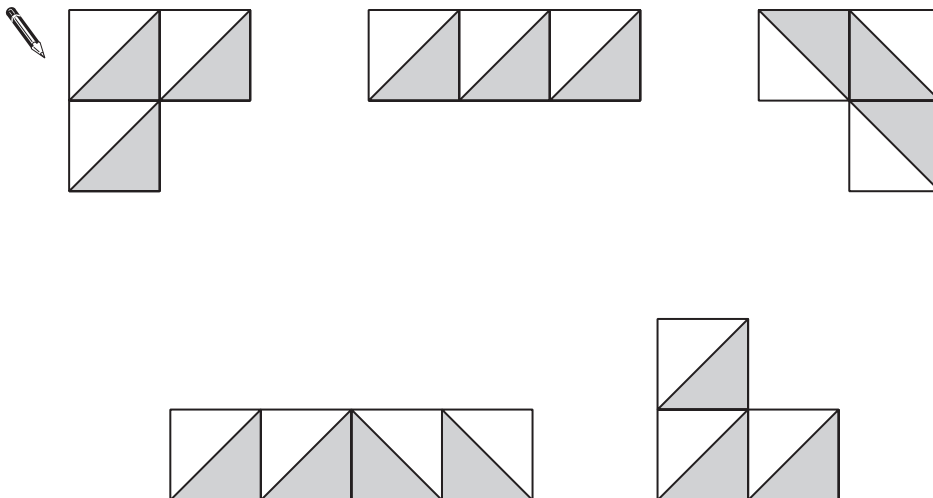

[2 marks]